

# TECSUN

# PL-368

FM STEREO / LW / MW / SW-SSB RECEIVER



**TECSUN ELECTRONIC IND. LTD.**



# CONTENTS

## GETTING STARTED

PL-368 at a glance .....	1
Powering your device .....	6
Charging the battery .....	6
Setting the clock .....	7
Setting the FM frequency range .....	7
Setting the MW (AM) frequency range and tuning step .....	7
Enabling/Disabling longwave (LW) .....	7

## USING THE DEVICE

Turning the device on/off .....	8
Volume control .....	8
VF (View Frequency) and VM (View Memory) .....	8
Using the radio's antennas .....	8
Tuning into stations .....	9
Manual tuning .....	9
Auto scan .....	9
Direct keypad entry .....	9
SW / SSB meter band selection .....	10
Working with station memories .....	10
Storing stations manually .....	10
Auto Tuning Storage (ATS) .....	11
Storing stations during auto scan .....	12
Listening to stored stations .....	12
Recalling stored stations .....	12
Memory scan .....	12
Deleting stored stations .....	13
Deleting a single station .....	13
Deleting stations during memory scan .....	13
Deleting all stored stations .....	14

Enhanced Tuning Mode (ETM+): An introduction .....	14
Using ETM+ to scan and store stations .....	17
Listening to stations in the ETM+ memory .....	17
Deleting a single ETM+ station .....	17

## **OTHER SETTINGS AND FEATURES**

Auto sorting memory .....	18
Single sideband (SSB) .....	18
Synchronous detection (SYNC) .....	18
AM bandwidth selection .....	19
FM stereo/mono selection .....	19
FM de-emphasis time constant .....	19
Display mode .....	20
Add seconds to the clock .....	20
Display backlight .....	20
Setting the sleep timer .....	20
Activating/Deactivating the alarm .....	20
Setting the alarm time .....	21
Setting the alarm station .....	21
Snooze function .....	22
Keylock .....	22
Temperature unit display (Celsius or Fahrenheit) .....	22



## **MISCELLANEOUS**

Synchronous detection: An introduction .....	23
Troubleshooting .....	26
Lithium battery safety instructions .....	27
Radio maintenance .....	27
PL-368 specifications .....	28

# PL-368 at a Glance – Location of Controls

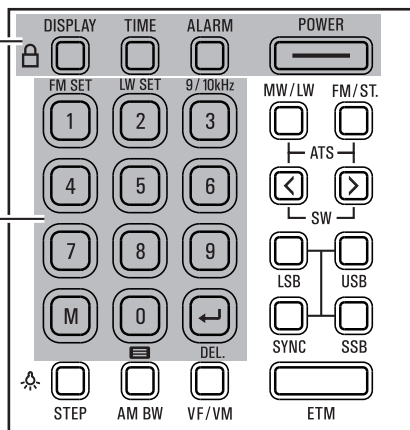
- DISPLAY/  : Display mode / Keylock
- TIME: Set / Display clock
- ALARM: Alarm setting
- POWER: Power switch / Sleep timer



- [ 0 ] - [ 9 ]: Numeric keys
- [ 1 ] / [ FM SET ]: FM range setting
- [ 2 ] / [ LW SET ]: Enable/Disable LW
- [ 3 ] / [ 9/10kHz ]: MW step setting
- [ 4 ]: FM de-emphasis switch
- [ 8 ]: Display seconds on clock
- [ 0 ] /  : Organize memory
- [ M ]: Store stations
-  / DEL. ]: Confirm/Delete

# PL-368 at a Glance – Location of Controls

SSB sideband selection

LSB: Lower sideband

USB: Upper sideband

SYNC: Synchronous detection

SSB: Enable/Disable SSB mode

Band selection / ATS

[ MW/LW ]: MW/LW

[ FM/ST. ]: FM/Stereo switch

[ < ], [ > ]: SW meter band selection

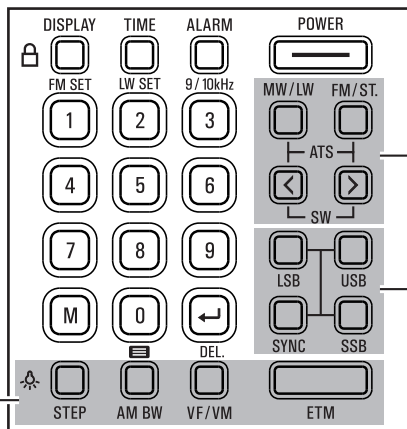

[ STEP /  ]: Tuning step selection / Display backlight

[ AM BW ]: AM bandwidth selection

[ VF/VM ]: View Frequency  $\Leftrightarrow$  View Memory

ETM: Enhanced Tuning Mode

# PL-368 at a Glance – Location of Controls

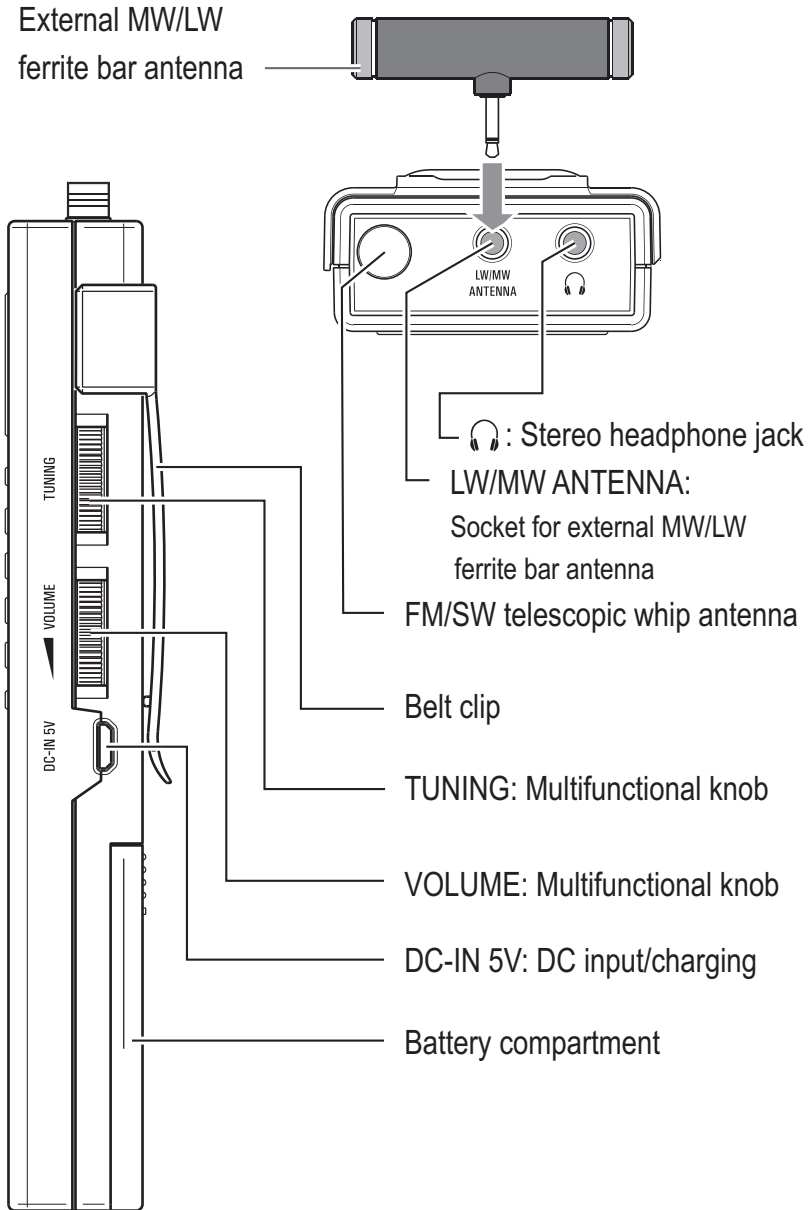

# PL-368 at a Glance – Display indication

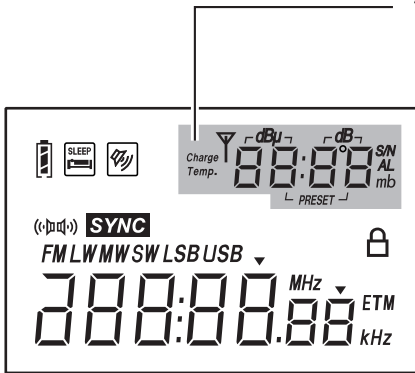

- \* dB $\mu$ : Signal strength unit
- dB: Signal-to-noise ratio unit
- S/N: Signal-to-noise ratio
- AL: Alarm time
- mb: SW/SSB meter band
- PRESET: Memory location
- Temp.: Temperature
- Charge: Charging indicator

## \* Display indication examples:

Signal strength/Signal to noise ratio:

$\nabla$   $\overline{\text{dB}\mu}$   $\overline{\text{dB}}$   $\text{SN}$   
1208

SW/SSB meter band:

31<sub>mb</sub>

Memory storage location:

138  
PRESET

ETM time-specific memory:

0609 (LW/MW)

E03 (SW)

Auto sorting memory:

P0C3

Already passed charging time:

Charge 02:30

Clock time:

13:38

Alarm time:

6:30<sup>AL</sup>

Temperature:

Temp. 26<sup>°C</sup> (Celsius)

Temp. 81<sup>°F</sup> (Fahrenheit)



# PL-368 at a Glance – Display indication

*kHz* : SW / MW / LW unit display

*ETM* : Enhanced Tuning Mode

▼ : Tuning step indicator

*MHz* : FM unit display

🔒 : Keylock

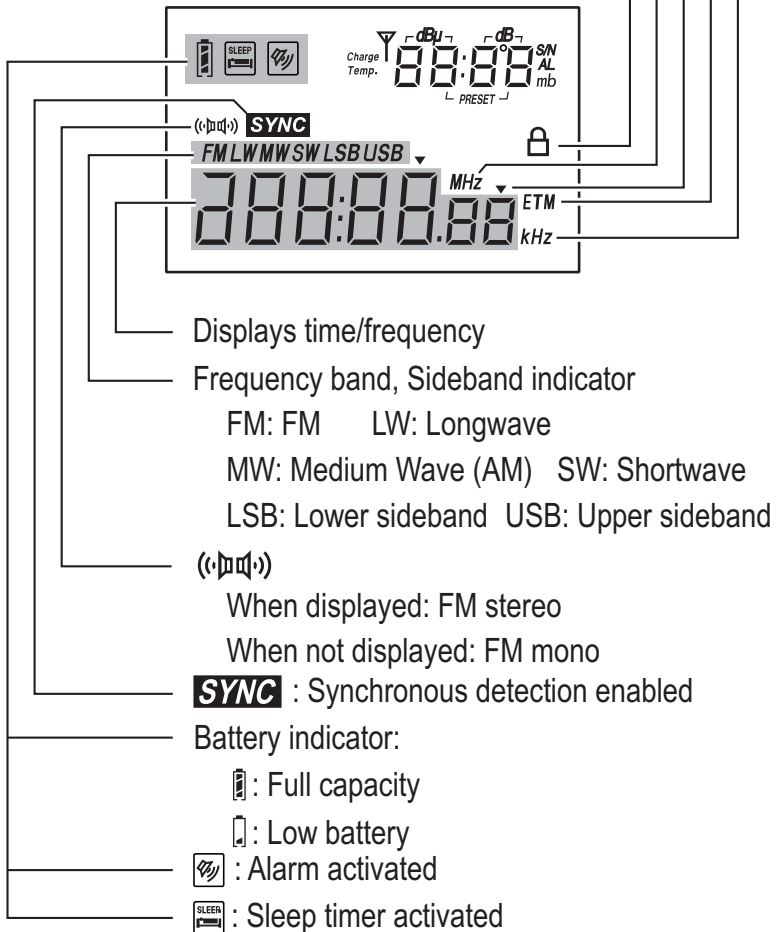

---



## Powering Your Device

This device is powered by a BL-5C 3.7V rechargeable lithium (Li-ion) battery. Open the battery compartment and install the battery following the correct polarity. The device can also be powered by connecting a DC 5V/0.5A power adapter to the micro-USB type-B socket.

Note: Connecting an external power supply causes interference when listening to radio frequencies. If experiencing reception difficulties, disconnect the external power supply and use a battery instead.

Attention! If you use a power adapter, assure that is appropriately certified and meets the standard requirements for an adapter in your region.

## Charging the Battery

When the battery icon is displayed as , this indicates that battery power is about to run out. Please charge it in time. To charge the BL-5C rechargeable lithium (Li-ion) battery, connect a DC 5V/0.5A charger to the USB socket on the right side of the radio using a micro-USB type-B charging cable. When charging, the charging time is displayed at the top right corner of the display while the "Charge" indicator flashes. When charging is complete, the battery symbol is displayed as  and the charging indicator "Charge" stops flashing.

Notes:

- Assure that the charger is appropriately certified and meets the standard requirements in your region.
- To avoid electrical noise interference, it is recommended not to charge the battery and listen to radio broadcasts at the same time.
- If the device is not used for a prolonged period of time, it is advisable to charge the battery once every 3 months for about 4 hours. This may extend battery life.

---

### Setting the Clock (24-hour format)

- 1) Press and hold [ TIME ] until the clock time starts flashing.
- 2) Use the numeric keys to enter the current time (hours + minutes is four digits), or rotate the [ TUNING ] and [ VOLUME ] knobs to adjust the time, and then press [ TIME ] to confirm the setting.

### Setting the FM Frequency Range

With the device off, set the frequency range to correspond with the country in which you are using the radio. Press and hold [ 1 ]. The display will show “64”, “76”, “87” or “88” to indicate the corresponding range: 64 ~ 108MHz, 76 ~ 108MHz, 87 ~ 108MHz or 88 ~ 108MHz.

Quick press [ 1 ] repeatedly to select your preference.

### Setting the MW (AM) Frequency Range and Tuning Step

With the device off, set the frequency range of MW (AM) to correspond with the country in which you are using the radio. Press and hold [ 3 ].

- Display indicates “9”: MW frequency steps are set at 9 kHz, and the frequency range is 522~1620 kHz (suitable for Asia, Europe, Africa, Oceania).
- Display indicates “10”: MW frequency steps are set at 10kHz, and the frequency range is 520~1710 kHz (suitable for North America and South America).

### Enabling/Disabling Longwave (LW)

With the device off, press and hold [ 2 ], the display shows “On” (enabled) or “Off” (disabled). To select the LW frequency band, power on the device and then quick press the [ MW/LW ] button twice.

## USING THE DEVICE

---

**Turning the device on/off:** Quick press the [ POWER ] button.

**Volume control:** Rotate the [ VOLUME ] knob upwards or downwards to select your desired volume level.

### **VF (View Frequency) and VM (View Memory)**

- **VF:** VF mode is used when searching for new radio signals. Press the [ VF/VM ] button. When the frequency indicator flashes twice, the VF mode is activated.
- **VM:** VM mode is used for looking up stations that have been stored into the memory. Press the [ VF/VM ] button. When the preset memory location indicator on the display flashes three times, the VM mode is activated.

### **Using the Radio's Antennas**

- **FM / Shortwave (SW):** When listening to FM or shortwave radio, extend the antenna and adjust its length and direction in order to get the optimum reception.
- **Medium Wave (MW) / Long Wave (LW):**  
This radio uses an internal ferrite bar antenna to receive medium wave and long wave broadcasts, the quality of which can be enhanced by changing the position and direction of the device. You may also choose to connect the external MW/LW ferrite bar antenna to the [ LW/MW ANTENNA ] socket (3.5mm). Once inserted, rotate the antenna in order to get the optimum reception.

---

## TUNING INTO STATIONS

Turn on the device, then quick press the [ FM/ST. ], [ MW/LW ], [ < ] or [ > ] (for SW) button to select your desired frequency band. You can tune into your favorite stations using any of the following tuning methods.

### Manual Tuning

In VF mode, rotate the [ TUNING ] knob to search for your desired stations. To change the tuning step, quick press [ STEP ], “▼” is displayed above the frequency.

Tip: Review the “Specifications” section (page 28) for an overview of the selectable tuning steps for each frequency band and mode (SSB/SYNC).

### Auto Scan

In VF mode, press and hold the [ VF/VM ] button. The device will automatically scan the entire frequency band for available stations. When a station is found it will stay there for about 5 seconds before continuing the search. To stop the auto scan feature, quick press any key.

### Direct Keypad Entry

In VF mode, quick press the numeric keys [ 0 - 9 ] to directly enter a frequency.

Tips:

- For FM band, ignore the decimal point when inputting frequency numbers. For example: enter 9, 7, 4 for FM 97.4 MHz.
- If the entered frequency is not within the covering range, the error “Err” symbol will be displayed.

---

## **SW / SSB Meter Band Selection**

Quick press [ < ] or [ > ] to change SW or SSB meter bands:

SW meter bands: 120m / 90m / 75m / 60m / 49m / 41m / 31m / 25m /  
22m / 19m / 16m / 15m / 13m / 11m

SSB meter bands: 160m / 80m / 60m / 40m / 30m / 24m / 20m / 17m /  
15m / 12m / 10m

## **WORKING WITH STATION MEMORIES**

This device can store 850 stations (presets) into memory: 100 each for FM and LW, 150 for MW (AM), 300 for SW, and 100 each for SSB and SYNC. You may choose any of the below methods to store stations.

### **Storing Stations Manually**

- 1) In VF mode, press the [ FM/ST. ], [ MW/LW ], [ < ] or [ > ] button to select the frequency band.
- 2) Tune into the new radio frequency to be stored.
- 3) Quick press the memory [ M ] button, "PRESET" will flash in the top right corner of the display to indicate the next available memory location. If desired, select a different memory location by using the [ TUNING ] knob or the numeric keys.
- 4) Quick press the [ M ] button again to confirm the location or wait for about 2 seconds to automatically store the station into memory.

---

## Auto Tuning Storage (ATS)

Automatically tune into and store FM, LW, MW and SW stations.

- Operation for FM and MW/LW:

- 1) Quick press [ FM/ST. ] or [ MW/LW ] to select the frequency band.
- 2) Press and hold the [ FM/ST. ] or [ MW/LW ] button until “PRESET” flashes and the frequency starts running.
- 3) When the frequency stops running, it means the ATS operation has been completed. Rotate the [ TUNING ] knob to view all the stored stations.

- Operation for SW:

There are two ATS modes for SW:

Mode A: Press and hold the [ < ] button to initiate ATS within all meter bands.

Mode B: Press and hold the [ > ] button to initiate ATS within the selected meter band.

Tips:

- ATS (except in SW mode B) replaces previously stored radio stations. To prevent this from happening, please consider using ETM+ (see page 14).
- ATS results for LW, MW and SW strongly depend on radio wave propagation conditions, the receiving environment and other factors. If the results are poor, try to initiate ATS at a different location and/or time, or tune into stations manually and then store them.
- For better ATS results in the LW, MW and SW bands, please also review the tips for ETM+ on page 16.

---

## Storing Stations During Auto Scan

To avoid any unwanted stations that might be stored during Auto Tuning Storage (ATS), store stations manually during "Auto Scan" (see also page 9).

- 1) In VF mode, press and hold the [ VF/VM ] button. The device will auto scan the entire frequency band for available stations. When a station is found it will stay there for about 5 seconds before continuing the search.
- 2) Quick press the memory [ M ] button to store a station, the radio will keep on scanning for the next available station.
- 3) To stop the auto scan feature, quick press the [ VF/VM ] button.

## LISTENING TO STORED STATIONS

### Recalling Stored Stations

- 1) Select the frequency band or mode (SYNC/SSB) of the stored stations that you wish to view.
- 2) Quick press the [ VF/VM ] button to enter the VM mode.
- 3) Rotate the [ TUNING ] knob to view the stored stations. Alternatively, use the numeric keys to enter the memory location directly. If there is no stored station at that location, the display shows " — — ".

### Memory Scan

The device can auto scan all stored stations within a frequency band or mode (SYNC/SSB), staying on each station for about 5 seconds before continuing.

- 1) Select the frequency band or mode (SYNC/SSB) for which you wish to view the stored stations.
- 2) Quick press the [ VF/VM ] button to enter the VM mode.
- 3) Press and hold the [ VF/VM ] button until "PRESET" flashes in the upper right corner of the display. The device starts to scan all stored stations. Quick press any button (except [ ← ] (DEL.)) to stop scanning.



---

## DELETING STORED STATIONS

### Deleting a Single Station

- 1) Enter the memory (VM) mode and select the station that you wish to delete.
- 2) Press and hold the [ ←J ] (DEL.) button until “*dEL*” and “*PRESET*” flash on the display.
- 3) Quick press the [ ←J ] button to confirm and delete the unwanted station.

Note: If the [ ←J ] button is not pressed for confirmation within 3 seconds, the delete function is exited automatically.

### Deleting Stations During Memory Scan

The device can auto scan all stored stations within a frequency band or mode (SYNC/SSB), staying on each station for about 5 seconds, and giving you the opportunity to delete any unwanted stored stations.

- 1) Select a frequency band or mode (SYNC/SSB).
- 2) Quick press [ VF/VM ] to enter the memory mode.
- 3) Press and hold the [ VF/VM ] button until “*PRESET*” flashes in the upper right corner of the display. The device starts to scan all stored stations and stays on each station for about 5 seconds before continuing.
- 4) Upon finding an unwanted station, press the [ ←J ] (DEL.) button. No confirmation is required and scanning continues immediately.
- 5) To stop the memory scan, quick press any button.

---

## Deleting All Stored Stations

It is possible to delete all stations from the memory (including ETM) simultaneously.

- 1) Turn the device off.
- 2) Press and hold the [  ] (DEL.) button until “dEL” and “ALL” flash on the display.
- 3) Quick press the [ POWER ] button to confirm and delete all stored stations.
- 4) Once the display returns to showing the clock time all stored frequencies have been deleted.

Note: If the [ POWER ] button is not pressed for confirmation within 3 seconds, the delete function is exited automatically.

## ENHANCED TUNING MODE (ETM+): AN INTRODUCTION

ETM+ allows you to auto tune and store FM, LW, MW and SW stations into the ETM memory. Unlike ATS (Auto Tuning Storage), scanned stations will not be stored into the regular memory (VM). In this way, when you are in a different city or country, you can use the ETM+ function to auto search new stations without overwriting any previously stored stations within the memory.

Unlike its predecessor ETM (Easy Tuning Mode), ETM+ can also be used for listening to LW, MW and SW stations more conveniently. Because signals in these frequency bands may only be available during a specific time of day, you can use this feature to make time-specific ETM memories.

---

### Example LW/MW

The ETM memory for LW/MW consists of 6 time-specific memories:

**0609:** 06:00 - 09:59

**1013:** 10:00 - 13:59

**1417:** 14:00 - 17:59

**1821:** 18:00 - 21:59

**2201:** 22:00 - 01:59

**0205:** 02:00 - 05:59

An ETM scan performed at 11:35 in the morning falls in the 10:00-13:59 hour time-range and any stations found are stored in ETM memory 1013.

### Example SW

The ETM+ memory for SW consists of 24 time-specific memories.

Stations found in the 09:00-09:59 period are stored in E09, 10:00-10:59 are stored in E10, and so on. In this way, an individual ETM memory can be made for each hour of the day.

When an ETM scan has already been made for a time period, the radio will automatically offer the frequencies belonging to the time period at which the ETM memory is entered.



For example, the picture on the right shows the starting screen that is briefly displayed

when entering the LW/MW ETM memory. In this example, "1013" indicates that the current listening time is between 10:00 and 13:59, whereas "15 ch" indicates that the last time an ETM+ scan was done during this time-range the device found 15 broadcasting frequencies.

---

The picture on the right shows the starting screen that is briefly displayed when entering the ETM memory for SW. In this example, “E20” indicates that the current listening time is between 20:00 and 20:59, whereas “136ch” indicates that the last time an ETM scan was done during this time-range the device found 136 broadcasting frequencies.



Tips:

- Time-specific ETM memories are based on the clock time of the radio. Before initiating an ETM scan, make sure to set the time accurately.
- If no previous ETM scan has been done for a specific time-range, the ETM memory will not show any stations. For example, the figure on the right indicates that no ETM scan has been performed during the 9:00-9:59 hour time-range.



- For LW/MW: The internal ferrite antenna is directional, you may need to adjust the position of the device or use the external ferrite bar antenna to improve ETM results. Due to the nature of radio wave propagation, longwave and medium wave reception is generally better at night than during the day.
- For SW: Radio signal propagation depends on the condition of the ionosphere, which itself is affected by a variety of factors (time of day, season of the year, sunspot cycles, etc.).
- For better ETM results, try to adjust the length of the whip antenna for FM and SW reception, or rotate the radio or the external ferrite bar antenna for better reception of MW and LW. Alternatively, try to find a different location within the building and preferably near a window.
- Electromagnetic interference (EMI) from household appliances, as well as the location within a building, affects ETM results.

---

## Using ETM+ to Scan and Store Stations

- 1) Quick press the [ ETM ] button, the display indicates “ETM”.
- 2) Select the frequency band.
- 3) Press and hold the [ ETM ] button to start scanning for stations.
- 4) When scanning is complete, the display shows the number of broadcast frequencies found (e.g. *136ch* ).

If the ETM scan missed certain stations (e.g. due to interference), then it is possible to add these to the ETM memory manually:

- 1) Quick press the [ ETM ] button, the display indicates “ETM” .
- 2) Select the frequency band.
- 3) Key in the frequency of the missing station using the numeric keypad.
- 4) Quick press the [ M ] button twice.

Note: For SW, ETM only scans/stores frequencies within the meter bands.

## Listening to Stations in the ETM+ Memory

- 1) Quick press the [ ETM ] button, the display indicates “ETM”.
- 2) Select the frequency band.
- 3) Rotate the [ TUNING ] knob to select a stored frequency.

Tip: To exit ETM mode, quick press the [ ETM ] or [ VF/VM ] button.

## Deleting a Single ETM+ Station

- 1) Quick press the [ ETM ] button, the display indicates “ETM”.
- 2) Select the frequency band.
- 3) Rotate the [ TUNING ] knob to select the frequency to be deleted.
- 4) Press and hold the [ ← ] (DEL.) button until the display shows “dEL”.
- 5) Quick press the [ ← ] button to confirm and delete the selected frequency.

Tip: To delete all ETM stations: review “Deleting All Stored Stations” (page 14).

## Other Settings and Features

---

### Auto Sorting Memory

This device can automatically organize all stored stations. In power off mode, press and hold the [  ] (0) button until the station memory preset indicator on the display starts running. This feature deletes duplicate stations and sorts the sequence of stored stations from low to high frequency.

### Single Sideband (SSB)

When receiving longwave, medium wave (AM) and shortwave signals, you can activate the SSB mode to receive particular signals like for example amateur radio communication and Morse Code, but it can also help to mitigate interference.

Enable/Disable SSB mode: Quick press [ LSB ] (lower sideband) or [ USB ] (upper sideband) to enable the sideband. Quick press [ SSB ] to disable SSB.

### Synchronous Detection (SYNC)

When listening to longwave, medium wave (AM) and shortwave broadcasts, turning on synchronous detection may reduce noise interference, eliminate distortion caused by local fading during signal transmission, and suppress interference caused by adjacent stations (see page 23 for more information).

Enable/Disable SYNC detection:

- 1) Press and hold [ SYNC ], the display shows “ **SYNC** ” and the radio enters the synchronous detection mode.
- 2) Quick press [ LSB ] or [ USB ] to select Lower Sideband or Upper Sideband SYNC detection.
- 3) To disable, quick press [ SYNC ] and “ **SYNC** ” disappears.

Note: Enabling the SYNC detector does not always reduce interference.

---

## AM Bandwidth Selection

Quick press [ AM BW ] repeatedly, or quick press and then rotate the [ VOLUME ] knob, to select a bandwidth to enhance the intelligibility of longwave, medium wave (AM) and shortwave signals. Selectable bandwidths are:

LW/MW: 2.5, 3.5, and 9.0kHz.

SW: 2.5, 3.5, and 5.0kHz.

SSB: 0.5, 1.2, 2.2, 3.0 and 4.0kHz.

- Wider bandwidth: Has better audio fidelity when receiving strong signals or local stations.
- Narrower bandwidth: Limits interference from adjacent strong signals and background noise, thereby especially suitable for receiving weak and distant stations.

## FM Stereo/Mono Selection

When listening to FM through headphones, quick press [ FM/ST. ]. If the device detects that the FM signal is in stereo the display shows the stereo “” icon. Quick press [ FM/ST. ] again to return to mono listening.

Note: When the FM signal is broadcasted in mono, or broadcasted in stereo but the signal received is weak, the audio output is in mono and “” is not displayed.

## FM De-emphasis Time Constant

While receiving FM broadcasts, long press [ 4 ] to adjust the de-emphasis setting to 50 $\mu$ s or 75 $\mu$ s.

“ 50.05 ”: For Europe, Australia, Japan (and most other locations).

“ 75.05 ”: For the Americas and South Korea.

---

## Display Mode

When listening to the radio, quick press [ DISPLAY ] repeatedly to select your preferred display mode. The top right corner of the display can show signal strength/signal-to-noise ratio, clock time, alarm time, temperature, or the memory location of the frequency (in VM mode only).

## Add Seconds to the Clock

With the device turned off, press and hold [ 8 ] to add seconds to the clock. Press and hold [ 8 ] again to hide the seconds from the clock.

## Display Backlight



With the device turned on, press and hold [  ] (STEP) to select your preferred backlight setting.

“  ”: Backlight turns on when a button or knob is used and turns off after 5 seconds.

“  ”: Backlight is set to always-off.

Note: After turning off the device, the backlight setting defaults to “  ”.

## Setting the Sleep Timer

- 1) Turn the device off.
- 2) Press and hold the [ POWER ] button to enter the sleep timer setting.
- 3) Rotate the [ TUNING ] knob to select a power-off timer of 1-120 minutes, or select “ON” to deactivate the sleep timer.
- 4) Quick press [  ] to confirm. The sleep timer “  ” icon is shown on the display.



## Activating/Deactivating the Alarm

Quick press [ ALARM ] to activate the alarm. The alarm “  ” icon is shown on the display to indicate that the device will turn on at the preset time. Quick press again to deactivate the alarm.





---

## Setting the Alarm Time

- 1) Press and hold [ ALARM ] until the alarm time in the upper right corner of the display starts flashing.
- 2) While still flashing, use the numeric keys to enter the time (4 digits in total), or rotate the [ TUNING ] knob to adjust the hour and the [ VOLUME ] knob to adjust the minutes, and then press [ ALARM ] to confirm. The display then automatically shows the duration of the alarm while “” and “” flash on the display.
- 3) Turn the [ TUNING ] knob to set the duration of the alarm (01 - 60 minutes).
- 4) Quick press [ ALARM ] to confirm the setting. The alarm “” icon is shown on the display.

## Setting the Alarm Station

- 1) Select the station frequency you want to use as the alarm.
- 2) Quick press [ M ], the preset memory location will flash.
- 3) While still flashing, quick press [ ALARM ], the alarm “” icon will flash.
- 4) While still flashing, quick press [  ] to confirm, “” stops flashing and the setting is complete.

### Tips:



- If the device is turned off with a volume level below 10, then upon reaching the alarm time, the device turns on at the default volume level of 10.
- Once the preset alarm time is reached, the radio turns on and stays on for as long as the alarm duration (01 – 60 minutes) was set. To turn off the device during the alarm playtime, quick press the [ POWER ] button twice.
- During the alarm playtime, quick press [ POWER ]. This will deactivate the alarm, after which you can change to a different frequency.
- If the device is not used for 3 days, the alarm deactivates automatically.

---

### **Snooze Function**

When the alarm goes off, press [ DISPLAY ] to temporarily turn off the alarm. The alarm icon “” flashes on the display and the alarm will go off again after 5 minutes. To turn off the snooze function, quick press the [ POWER ] button.

### **Keylock**

To activate the keylock, press and hold [  ]. The lock “” icon is displayed and the buttons and knobs are disabled. Press and hold [  ] again to unlock.

### **Temperature Unit Display (Celsius or Fahrenheit)**

When the MW (AM) tuning step is set to 9 kHz, the temperature unit display defaults to Celsius. When set to 10 kHz the temperature is displayed in Fahrenheit. See page 7 for information about changing the MW (AM) tuning steps.

## **Synchronous Detection: An introduction**

---

For demodulating AM signals, most radios use diode envelope detectors. When the amplitude modulated signal passes through the inductor-capacitor loop, it will produce distortion, and the envelope detector will also produce distortion. Therefore, one of the best ways to demodulate the AM signal is to use a synchronous detector.

The synchronous detector reconstructs the unmodulated carrier frequency based on the input signal, and uses this as a reference to identify noise and distortion. Synchronous detection technology is often used in FM stereo left and right channel signal demodulation and color TV chrominance signal demodulation.

Synchronous detection has a high detection efficiency and can realize small signal detection. It can eliminate the distortion (transient intermodulation distortion) generated in the IF filter due to local fading, slight offset, modulation overshoot, as well as inter-channel interference and cross-talk modulation, and can also reduce noise interference.











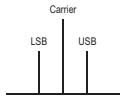
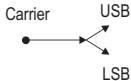



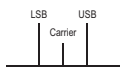
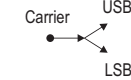

The chart (on the next page) shows some common amplitude modulation phenomena:

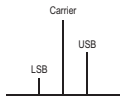
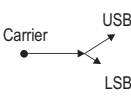
Example 1: It is an undisturbed conventional amplitude modulation signal, both detectors give distortion-free output.

Example 2: The carrier is reduced because of local fading or the directivity of the transmitting antenna.

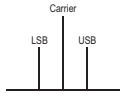
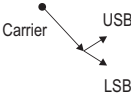
Example 3: Sideband asymmetry is caused by local fading or reception detuning.

Example 4: The carrier phase shift is caused by the asymmetry of the skywave transmission or radio intermediate frequency phase.

	Spectrum	Phasor Diagram	Signal	Envelope Detector Output	Synchronous Detector Output
1					
2					
3					
4					

The chart shows the demodulation output waveforms of the envelope detector and synchronous detector. In each situation, the synchronous detector gives an undistorted output (the frequency response may be uneven, but there is no distortion). This is not the case with the envelope detector. The envelope detector can only work correctly when the carrier is large enough and the upper and lower sidebands are complete mirror images of each other in amplitude and phase.

Synchronous detectors do not have the limitations of envelope detectors and can demodulate a wide range of AM signals, for example double-sideband, double-sideband with a suppressed carrier (DSB-SC), single sideband without a carrier or with a suppressed carrier, vestigial sideband (VSB), quadrature AM (QAM) and other signals.

---

These forms of amplitude modulation, which cannot be demodulated by the envelope detector, arise from fairly common situations. Although the broadcast signal is transmitted as a conventional double-sideband AM wave, the detuning and skywave reflection of the radio will change this AM signal into one or a combination of the forms shown in the chart.

When there is adjacent channel interference, TV horizontal scanning harmonics, interference of the carrier frequency and the like, then using the upper sideband or lower sideband to receive the unaffected sideband can significantly reduce the interference. This is because these types of interference usually only affect one sideband of the AM signal, and the content of AM radio broadcasts exists in two sidebands, in which each sideband contains the same content.

# Troubleshooting

ISSUE	POSSIBLE CAUSE / SOLUTION
Unable to power on the device.	Battery has no power or is installed incorrectly. <ul style="list-style-type: none"> <li>● Replace or charge the battery.</li> <li>● Reinstall the battery.</li> </ul>
Radio auto turns off while listening.	Battery has no power or the sleep timer is activated. <ul style="list-style-type: none"> <li>● Replace or charge the battery.</li> <li>● Deactivate the sleep timer and turn the radio back on.</li> </ul>
ATS and ETM skip stations, or some stored stations have only noise.	The radio signal is too weak, there is strong interference, or MW (AM) tuning steps are not set accurately. <ul style="list-style-type: none"> <li>● Search and store stations manually.</li> <li>● Adjust the length and direction of the antenna or change to a different location and try again.</li> <li>● The MW tuning steps may have been set incorrectly. Please review page 7 and then try again.</li> </ul>
Poor MW reception while using in North or South America.	MW (AM) stations are spaced at 10 kHz in the Americas, the device may be set to 9 kHz tuning steps. <ul style="list-style-type: none"> <li>● Turn off the device, then press and hold the [ 3 ] button to change the MW tuning step to 10 kHz.</li> </ul>
Unable to enter the ETM memory.	The radio is in SSB or SYNC mode. <ul style="list-style-type: none"> <li>● First exit the mode by pressing the [ SSB ] or [ SYNC ] button, and then enter the ETM memory.</li> </ul>
When the alarm goes off the radio broadcast is only noise.	Alarm preset radio frequency was not properly set, or there are no broadcasts at that time. <ul style="list-style-type: none"> <li>● Assure that receiving a broadcast is possible at the alarm time and the location where the device is placed.</li> </ul>

---

## **Lithium Battery Safety Instructions**

- Improper replacement of the lithium battery may result in an explosion. Replace only with a lithium battery of the same type or equivalent (the lithium battery used in this device is a BL-5C rechargeable lithium battery).
- Do not expose the battery to heat sources (e.g. sunlight, fire), low temperatures, humidity, or high pressure.
- Do not short-circuit or disassemble the battery. If the battery is seriously inflated, please do not continue to use it. Dispose of the battery properly and prevent children from playing with electric currents.
- If not using for an extended period of time, remove the battery and store it in a safe manner. Please use non-conductive material to wrap the battery in order to avoid direct contact with metal. You can avoid performance loss by keeping the battery in a cool dry place.
- Please consciously abide by aviation regulations; lithium batteries are strictly prohibited from placing into checked luggage.

## **Radio Maintenance**

- Keep it dry. Rain, humidity and other types of liquids or moisture can contain minerals that may cause corrosion to components. If the device does accidentally get wet, remove the battery and wait for the radio to dry completely before placing it back.
- Do not place or store the device in environments above +45°C. High temperatures can shorten the life span of certain components.
- Do not place or store the device in cold environments below -5°C . Otherwise, once the surrounding temperature rises, internal condensation may develop and damage the circuit board and LCD display.
- Do not drop, hit, or smash the device.
- Do not use harsh chemicals, cleaning solvents, or strong detergents to clean the device. Use a clean, soft, dry cloth to clean the screen.
- Do not attempt to disassemble the device to adjust internal parameters.

# PL-368 Specifications

---

## Frequency range

Longwave (LW):	153-513 kHz
Medium wave (MW):	520-1710 kHz / 522-1620 kHz
Shortwave (SW):	1711-29999 kHz
FM:	64-108 / 76-108 / 87-108 / 88-108 MHz

## Frequency tuning steps

### Longwave (LW)

AM broadcast:	9 kHz / 1 kHz
Single sideband:	9 kHz / 1 kHz / 10 Hz
Synchronous detection:	9 kHz / 1 kHz / 100 Hz

### Medium wave (MW):

520-1710 kHz

AM broadcast:	10 kHz / 1 kHz
Single sideband:	10 kHz / 1 kHz / 10 Hz
Synchronous detection:	10 kHz / 1 kHz / 100 Hz

522-1620kHz

AM broadcast:	9 kHz / 1 kHz
Single sideband:	9 kHz / 1 kHz / 10 Hz
Synchronous detection:	9 kHz / 1 kHz / 100 Hz

### Shortwave (SW):

AM broadcast:	5 kHz / 1 kHz
Single sideband:	5 kHz / 1 kHz / 10 Hz
Synchronous detection:	5 kHz / 1 kHz / 100 Hz

FM: 100kHz / 10kHz

## Station memories (excl. ETM):

Longwave:	100
Medium Wave (AM):	150
Shortwave:	300
FM:	100
SSB:	100
SYNC:	100



---

**Noise limit sensitivity**

Longwave (S / N = 26dB):	< 10mV / m
Medium wave (S / N = 26dB):	< 1mV / m
Shortwave (S / N = 26dB):	< 20 $\mu$ V
FM (S / N = 30dB):	< 3 $\mu$ V

**Selectivity**

Longwave:	> 60dB
Medium wave:	> 60dB
Shortwave:	> 60dB
FM:	> 60dB

**Sync Detection Lock Range:**  $\pm$  1kHz

<b>IF Frequency (DSP):</b>	AM 45 kHz; FM 128 kHz
<b>FM Stereo crosstalk (headphone output):</b>	35dB
<b>Speaker:</b>	16 $\Omega$ , 0.5W
<b>Stereo headphone impedance:</b>	32 $\Omega$
<b>Maximum output power:</b>	Approx. 350mW
<b>Quiescent Current:</b>	< 25mA (FM/MW/LW) < 45mA (SW)

<b>Stand-by current:</b>	< 90 $\mu$ A
<b>Power supply:</b>	3.7V BL-5C Li-ion battery or external DC 5V
<b>Charging / external power:</b>	DC 5V $\overline{\text{---}}$ 500mA

<b>Unit size (with antenna contracted):</b>	162 x 53 x 26 mm
<b>Weight (excluding battery):</b>	130g

# **TECSUN**

**RADIOS AUSTRALIA**

## **TECSUN RADIOS AUSTRALIA**

---

24/9 Powells Road, Brookvale, NSW 2100 Australia  
Email: [info@tecsunradios.com.au](mailto:info@tecsunradios.com.au)

Ph: +61 2 9939 4377  
[www.tecsunradios.com.au](http://www.tecsunradios.com.au)